

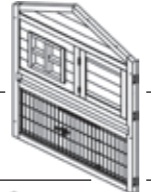









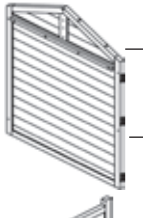
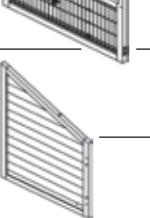
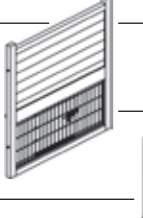
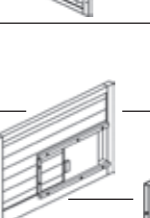
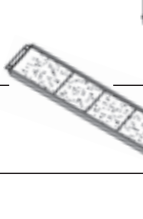
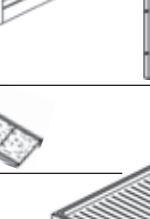
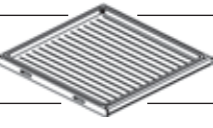
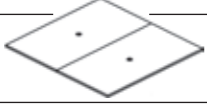
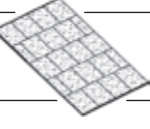
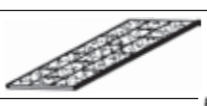
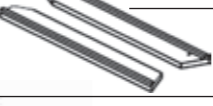



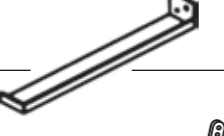

Pos.	Beschreibung Description	Maße Measurement	Anzahl Quantity	Art.-Nr. Item
1	Vorderteil, links Front panel, left	 760 x 1040 x 25 mm	1	62335-10
2	Vorderteil, rechts Front panel, right	 630 x 850 x 25 mm	1	62335-11
3	Rückwand, links Back panel, left	 760 x 1040 x 25 mm	1	62335-20
4	Rückwand, rechts Back panel, right	 630 x 850 x 25 mm	1	62335-21
5	Seitenteil, links Left side panel	 660 x 860 x 25 mm	1	62335-30
6	Mittelwand Middle-panel	 660 x 520 x 25 mm	1	62335-34
7	Seitenteil, rechts Right side panel	 660 x 560 x 25 mm	1	62335-31
8	Rampe Ramp	 670 x 20 x 170 mm	1	62335-41
9	Ausziehbare Bodenwanne Drawer with plastic inlay	 710 x 50 x 690 mm	1	62335-40
10	Mittelboden, 2-tlg. Mid-floor, two-part	 710 x 12 x 655 mm	1	62335-60
11	Dachplatte, rechts Right roof part	 1165 x 12 x 765 mm	1	62335-51
12	Dachplatte, links Left roof part	 465 x 12 x 765 mm	1	62335-50
13	Abschlussleiste Dach, links Final batten for roof, left	 470 x 60 x 25 mm	2	62335-62
14	Abschlussleiste Dach, rechts Final batten for roof, right	 1160 x 60 x 25 mm	2	62335-63
15	Dachfirst Roof ridge	 70 x 8 x 740 mm	1	62335-61

Pos.	Beschreibung Description	Größe Size	Anzahl Quantity	Art.-Nr. Item	
A	Senkkopfschraube Countersunk screw	 M3,8 x 50 mm	14+1	6233-60	
B	Senkkopfschraube, schwarz Countersunk screw, black	 M3,8 x 16 mm	2+1		
C	Senkkopfschraube Countersunk screw	 M3,8 x 35 mm	8+1		
D	Senkkopfschraube Countersunk screw	 M3,8 x 60 mm	2+1		
E	Senkkopfschraube Countersunk screw	 M3,8 x 40 mm	12+1		
F	Senkkopfschraube Countersunk screw	 M3,8 x 25 mm	4+1		
G	Metall Fixierung Metal fixation, incl. screws	 plus 2 Schrauben H plus 2 screws H	214 x 30 x 30 mm 1		
H	Linsenkopfschraube mit Mutter, schwarz Lenshead screw with nut, black	 M4 x 35	2+1		
I	Fangband, rechts Right check strap	 plus 8 Schrauben J plus 8 screws J	28 cm 1		6235-60
J	Linsenkopfschraube Lenshead screw	 M3,8 x 16 mm	8+1		
K	Verschlussriegel Locking bolt	 plus je 1 Schraube L plus 1 screw L for each	7 cm 2	6235-56	
L	Senkkopfschraube, schwarz Countersunk screw, black	 M3,8 x 30 mm	2+1		

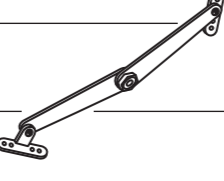
Weitere bereits vormontierte Teile (als Ersatzteile separat erhältlich)
Other parts already assembled (spare parts separately available)

Beschreibung Description	Größe Size	Anzahl Quantity	Art.-Nr. Item
Scharnier für Tür des Auslaufs, inkl. Schrauben Hinge for door of enclosure, incl. screws	5 cm	2	6235-72
Scharnier für Tür des Stalls, inkl. Schrauben Hinge for door of the hutch, incl. screws	3,8 cm	2	6235-70
Scharnier für Dach des Stalls, inkl. Schrauben Hinge for roof of the hutch, incl. screws	7,6 cm	3	6235-74

ⓘ Sie finden eine französische und italienische Anleitung unter der jeweiligen Artikel-Nummer auf www.trixie.de.
 ⓘ Please find instructions in French and Italian under the corresponding item number at www.trixie.de.
 ⓘ Vous trouverez les informations détaillées en français et en italien à chaque référence d'article, sur notre site www.trixie.de.
 ⓘ Le istruzioni in italiano e francese sono disponibili selezionando il codice dell'articolo sul nostro sito www.trixie.de.

- Ⓓ Verbinden Sie das linke (1) und das rechte Vorderteil (2) mit der Kunststoff-Steckverbindung, sowie auch die linke (3) und rechte Rückwand (4). Befestigen Sie die Metall-Fixierung (G) am unteren Rand der rechten Rückwand.

- Ⓔ Connect the left (1) and right front panel (2) by plastic cam-lock, as well as the left (3) and right back panel (4). The metal fixation (G) has to be fixed to the lower edge of the right back panel.

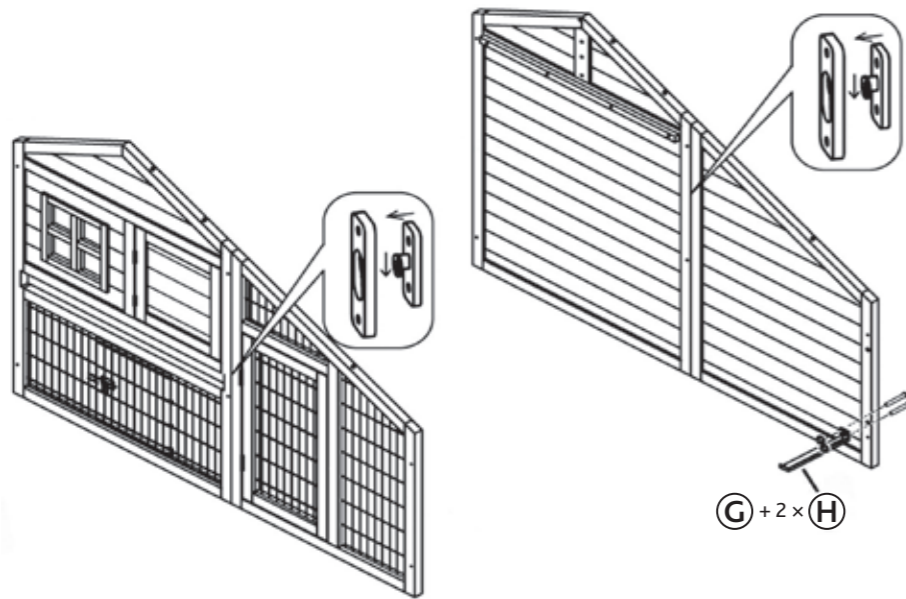

1.

- Ⓓ Befestigen Sie zuerst die beiden Seitenteile (5/7) sowie die Mittelwand (6) mit der Vorderseite. Danach schrauben Sie die Rückwand fest.

- Ⓔ First fasten both side panels (5/7) as well as the middle panel (6) with the front. Then screw the back wall.

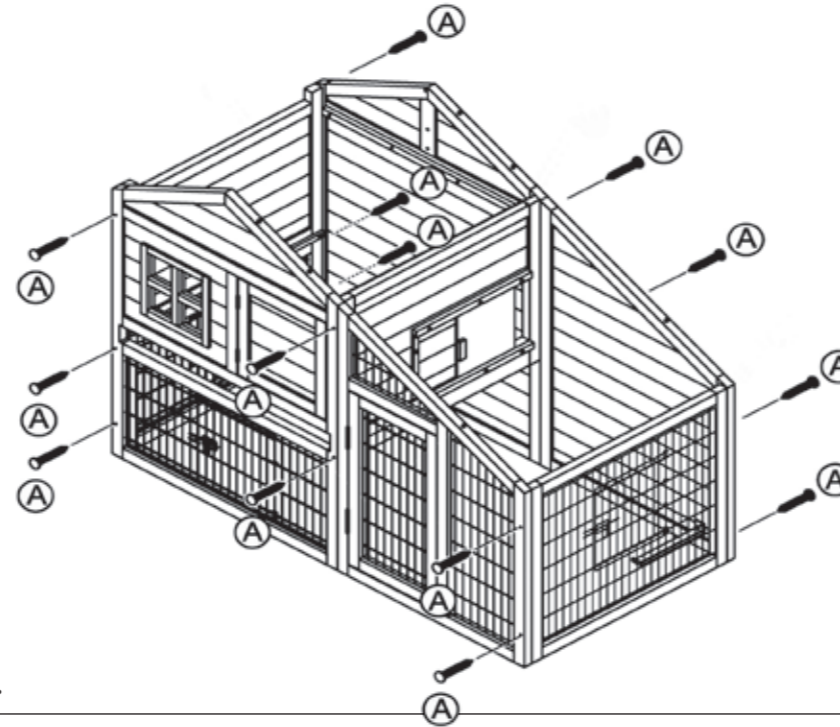

2.

- Ⓓ Setzen Sie die Rampe (8) ein und schrauben Sie sie fest. Danach wird die Bodenwanne (9) eingeschoben und der Mittelboden (10) eingesetzt.

- Ⓔ Put in the ramp (8) and tighten it. Insert the drawer (9) and as well as the mid-floor (10).

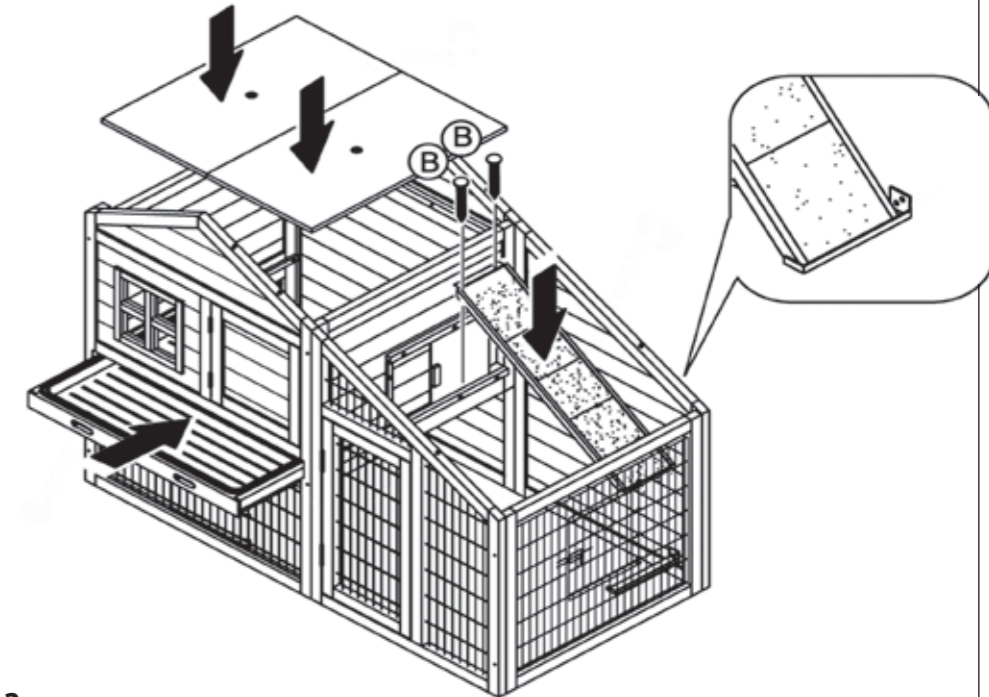

3.

- Ⓓ Befestigen Sie den rechten Teil des Daches (11), dann verschrauben Sie die linke Seite (12). Montieren Sie nun das Fangband (I) an der Innenseite des Daches und der Rückwand.

- Ⓔ Fix the right part of the roof (11), then screw the left part (12). Now screw the check strap (I) on the inner side of the roof and the back wall.

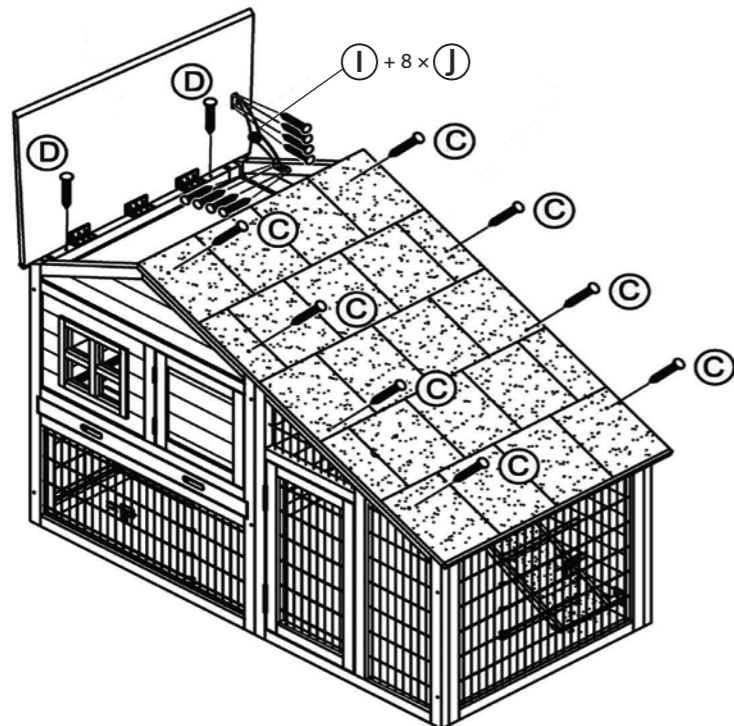

4.

- Ⓓ Jetzt befestigen Sie noch die Abschlussleisten (13/14) an den Dachüberständen und verschrauben den Dachfirst (15) mit der linken Dachhälfte.

- Ⓔ Fasten the final battens (13/14) at the eaves and fix the roof ridge (15) on the left roof part.

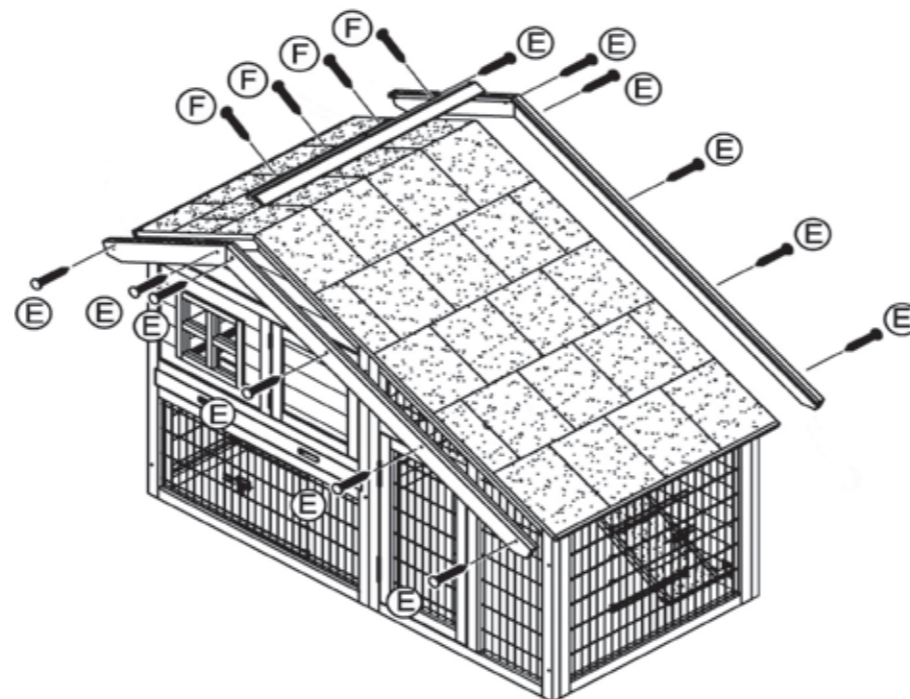

5.

- Ⓓ Schrauben Sie die Verschlussriegel (K) neben die Türen.

- Ⓔ Screw the locking bolts (K) beside the doors.

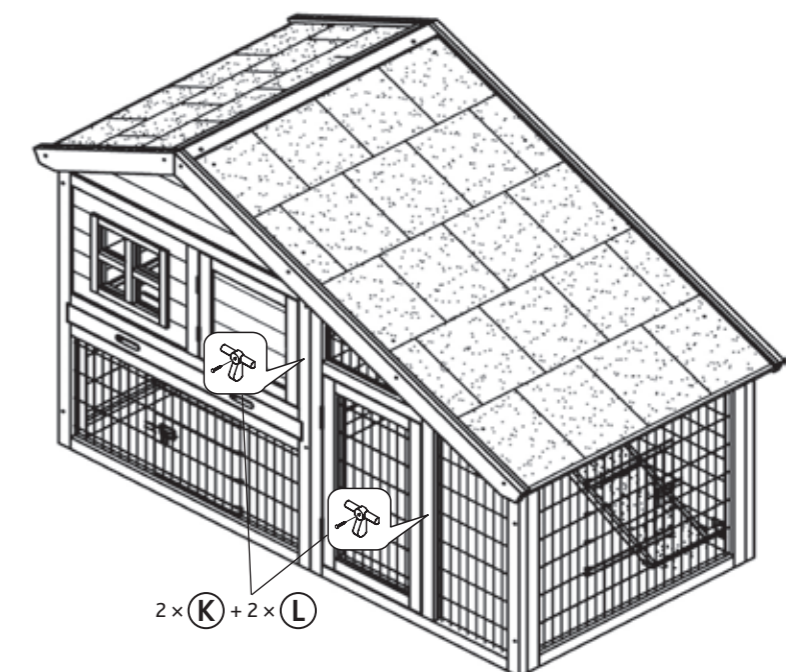

6.