











Pos.	Beschreibung Description	Maße Measurement	Anzahl Quantity	Art.-Nr. Item
1	Eckpfeiler Corner pillars		4	5571-20
2	Bodenplatte Bottom plate		1	5571-10
3	Dach Roof		1	5571-30
4	Dachfirst Roof ridge		1	5571-40
5	Beine Legs		3	5571-50
6	Stamm Trunk		1	5571-51
7	Verstärkung (2-tlg.) Brace (2-parts)		1	5571-52

Pos.	Beschreibung Description	Größe Size	Anzahl Quantity	Art.-Nr. Item
A	Senkkopfschraube Countersunk screw		ø 3,5 x 35 mm	12+1
B	Senkkopfschraube Countersunk screw		ø 3,5 x 25 mm	3+1
C	Senkkopfschraube Countersunk screw		ø 3 x 20 mm	4+1
D	Senkkopfschraube Countersunk screw		ø 3,5 x 50 mm	3+1

5570-60

Ⓧ Sie finden eine französische und italienische Anleitung unter der jeweiligen Artikel-Nummer auf www.trixie.de.
 Ⓧ Please find instructions in French and Italian under the corresponding item number at www.trixie.de.
 Ⓧ Vous trouverez les informations détaillées en français et en italien à chaque référence d'article, sur notre site www.trixie.fr.
 Ⓧ Le istruzioni in italiano e francese sono disponibili selezionando il codice dell'articolo sul nostro sito www.trixie.it.

Ⓧ Verschrauben Sie die Eckpfeiler (kurze Seite nach außen) mit der Bodenplatte.
 Ⓧ Screw the corner pillars (short side outwards) with the bottom plate.

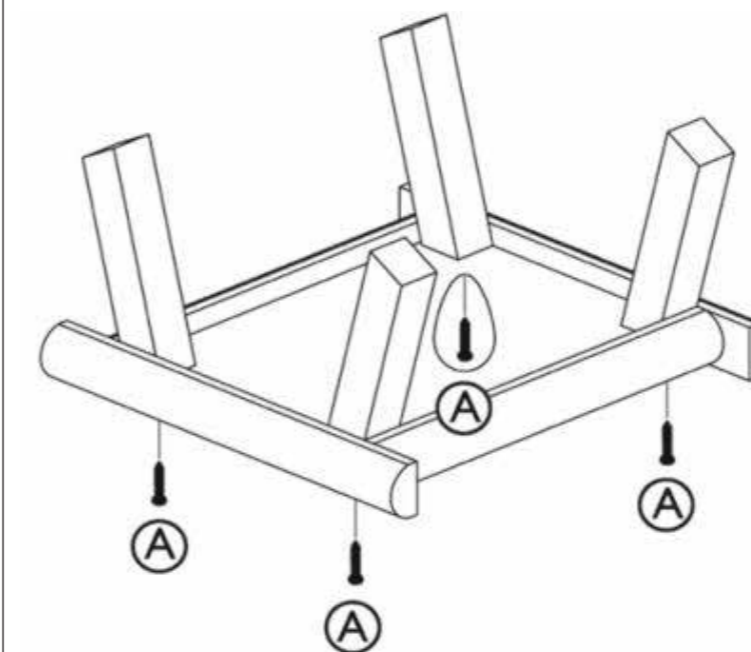

1.

Ⓧ Befestigen Sie das Dach an den Eckpfeilern und verschrauben Sie den Dachfirst.
 Ⓧ Fix the roof to the corner pillars and screw the ridge.

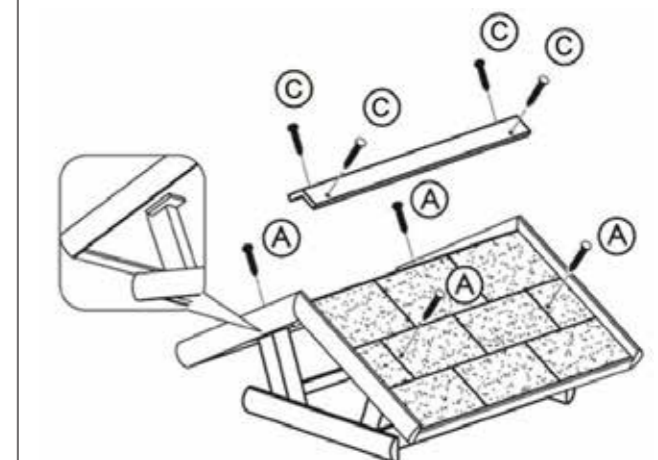

2.

Ⓧ Befestigen Sie die Beine am Stamm und stabilisieren Sie diese mit der Verstärkung.
 Ⓧ Attach the feet to the stand and stabilise it with the brace.

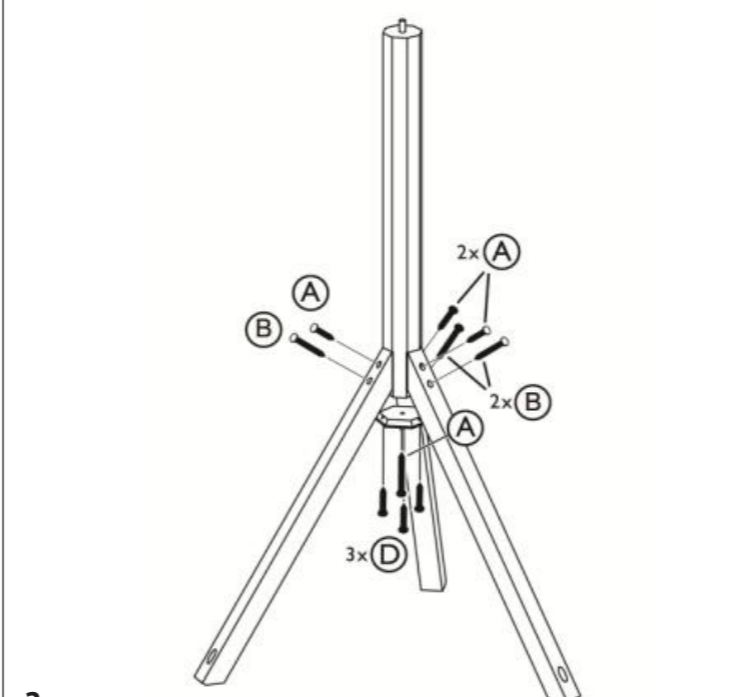

3.

Ⓧ Setzen Sie das zusammengeschaubte Haus auf den Stamm und fixieren Sie es mit der Flügelschraube.
 Ⓧ Put the completed house on the stand and fix it with the wing bolt.



4.